

UniBloc Performance Balances

UP Series



UP Series

UniBloc Performance Balances

Superior Response Significantly Increases Weighing Efficiency

High Speed

The display response time for weighing minute quantities (from about ten times the minimum display value) is about one second. That significantly improves weighing efficiency.

Toughness

Using the highly impact-resistant UniBloc sensor minimizes downtime due to malfunctions.

Stress Free

The STABLO-AP ionizer (optional) eliminates static electricity effects to provide highly reliable measurements without any time-consuming steps.



Large Pan with 0.01 g
Minimum Display Value

- UP2202X
- UP2202Y
- UP4202X
- UP4202Y
- UP6202X
- UP6202Y



Large Pan with 0.1 g
Minimum Display Value

- UP4201X
- UP4201Y
- UP8201X
- UP8201Y

Movie that explains UP-series features in easy-to-understand terms.
https://www.shimadzu.com/an/balance/toploading/up_video.html



Small Pan with 0.001 g
Minimum Display Value

- UP223X • UP223Y • UP423X • UP423Y
- UP623X • UP623Y • UP823X • UP823Y
- UP1023X • UP1023Y



Small Pan with 0.01 g
Minimum Display Value

- UP422X • UP422Y
- UP822X • UP822Y

High Speed

High-speed weighing significantly improves efficiency of weighing operations.

Significantly Improved Response Provides Fastest Response Performance in Its Class **NEW**

Advanced digital control technology shortens display response times to about one ninth of previous values when weighing minute quantities, which significantly improves work efficiency.

Response for Weighing Minute Quantities

Large pan model with 0.01 g minimum display value
Small pan model with 0.001 g minimum display value

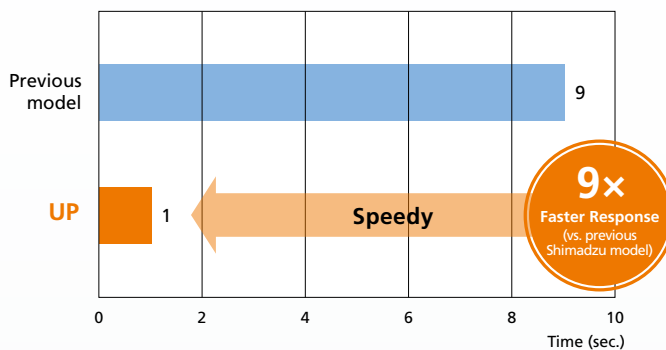

Measurement Conditions:

Large pan model with 0.01 g minimum display value and 0.1 g load
Small pan model with 0.001 g minimum display value and 0.01 g load

UP-Wind Break (large pan windbreak) (only for large pan models with 0.01 g minimum display value)

Newly designed UP-Wind Break included standard. It successfully reduces effects from drafts, such as from air conditioners, which helps improve the efficiency of weighing operations.

Comparison of Display Instability Due to Blower

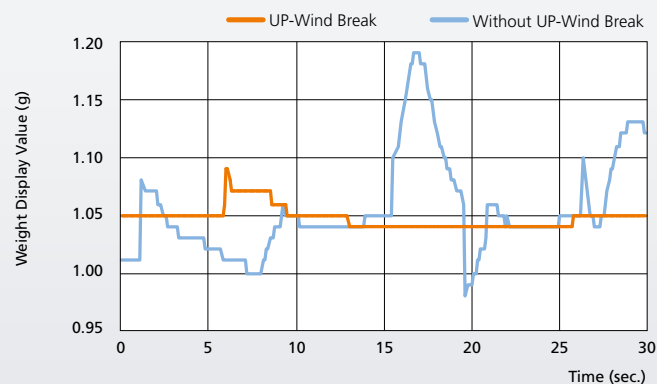

Toughness

Highly Impact-Resistant UniBloc Sensor Minimizes Downtime

The aluminum UniBloc integrated sensor mechanism is precisely machined from a single block of aluminum alloy.

Because it integrates all the components used in the previous sensor unit without the need for any fastening screws, it is fastened without deflecting the elastic fulcrum, resulting in an exceptionally impact-resistant sensor that is unlikely to ever fail.

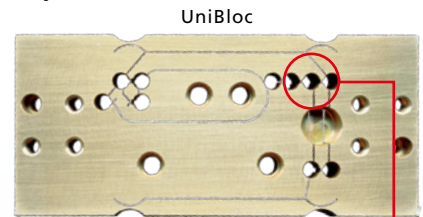

Illustrations of Balance Mechanism, Assembled Balance, and UniBloc Balance

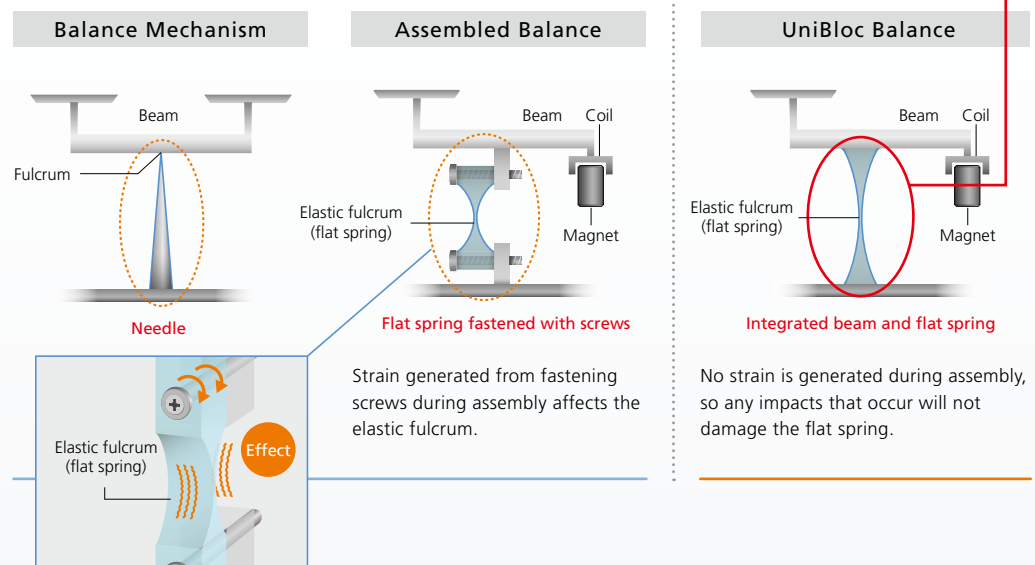

One Million-Cycle Endurance Testing

Engineered with the impact-resistant UniBloc sensor, they pass endurance testing with one million cycles.*



Appearance of Endurance Testing

* Endurance Testing

Method: A 1-kg weight is moved on and off the pan at 1.5-second cycles.

Pass/fail criterion: Satisfies Shimadzu standards for routine inspections after the on-off cycles.

Note: Japan's Measurement Act specifies endurance testing to 100,000 cycles.

UP series balances are tested to over ten times that level.

Full Aluminum Die Cast Housing Provides Excellent Chemical Resistance

The housing of UP series models is made completely of die cast aluminum. That makes them highly resistant to chemicals and corrosion for many years of worry-free operation.

Stress Free

Static Electricity Solutions for Improved Operability

Static Remover (Ionizer)

STABLO-AP

STABLO-AP Ionizer (Static Remover)

AP Series Analytical Balances Available with the Ionizer Installed Internally (optional, sold separately)

The STABLO-AP (optional) is Shimadzu's solution for static electricity. By maintaining a superior ion balance, the static remover is especially useful for weighing powder and film samples. Static electricity can cause measurement values to fluctuate or drift, even for 1 mg or 10 mg-level quantities. In addition to solving fluctuation and drift problems, the STABLO-AP also can improve work efficiency by preventing powder from clinging to spatulas.

Reliably Removes Static Charge

Uses AC Ionization for a Good Ion Balance

- Never causes reverse charging.
- Can remove a wide range of static charge.
- Reliable performance for long periods.
- Long 30,000-hour service life.

Removes Static Quickly without Wind

Space-Saving Design

Compact main unit can be hand-held or fastened.



Significantly Faster Static Elimination

It eliminates the effects of static electricity to ensure weighing operations can be performed without extra work. Efficiently eliminates static from powder samples, weighing paper, containers, and other surfaces.

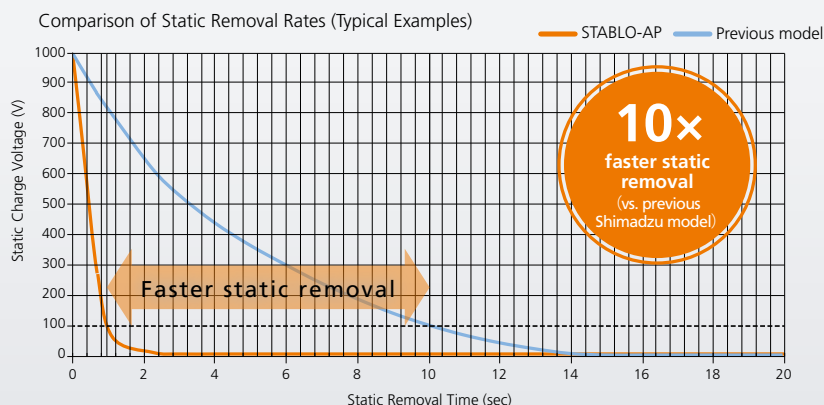

Measurement Conditions

- Time from ± 1000 V to ± 100 V
- 100 mm distance between CPM and ionizer
- Evaluated using a 150 x 150 mm 20 pF charged plate monitor (CPM)

Have you experienced the following static electricity symptoms?

● Measurement values have poor reproducibility or fluctuate

● Powder clings to container or spatula

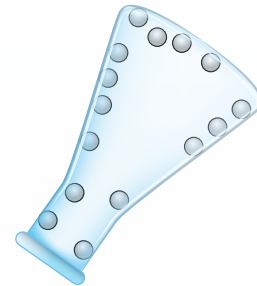
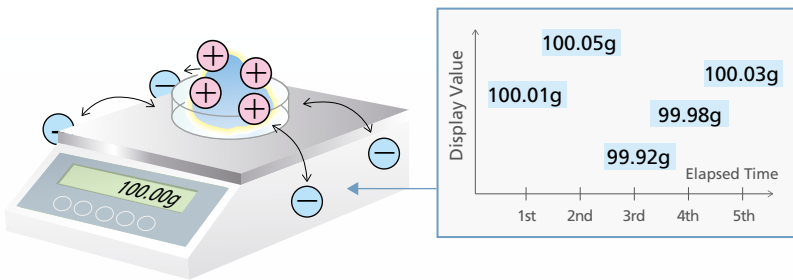

AC Method Produces Excellent Ion Balance

The AC method applies an AC current to the discharge needle to emit equal quantities of positive and negative ions from a single electrode. The DC method applies a positive or negative DC voltage to each of two electrodes, so that they emit corresponding ions. If the electrodes are too far away, the charge removal range is limited. Also, any deterioration on the discharge needles can make the ion balance worse.

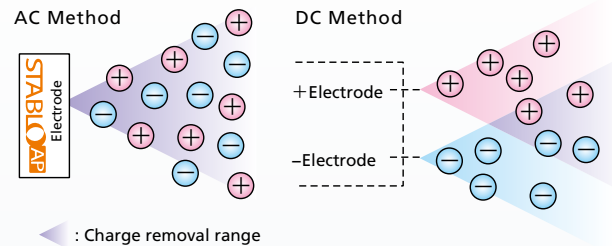

Ion Balance

Ion balance is the balance of positive and negative ions supplied by an ionizer. A poor ion balance can prevent neutralizing static electricity or cause reverse charging.

If ion balance is poor

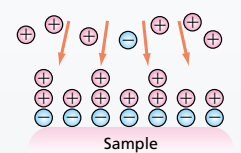
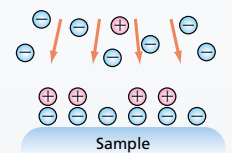

Static Electricity Removal by Ion Irradiation

When weighing easily charged samples or containers, static electricity can affect display values, such as by causing instability. The Shimadzu STABLO-AP ionizer achieves accurate and stable measurements by emitting a good balance of ions generated by an AC corona discharge to reduce the static charge.

Concept of Static Removal

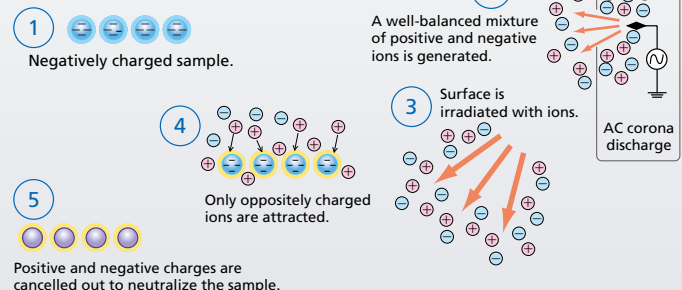

Efficiency & Productivity

Connecting to a Computer and PLC

Balance Keys Weighing Data Collection Software

(for Windows®)

Once Balance Keys Windows®-based software is installed, analytical balance data can be easily loaded into Excel® or other software. The software can be downloaded free from the analytical balance website. Configuring settings for connecting to the analytical balance is simple and the software will help save labor and reduce transcription and other errors. It is also easy to record changes over time by specifying the output interval setting on the analytical balance.

[Select Balance model Window]

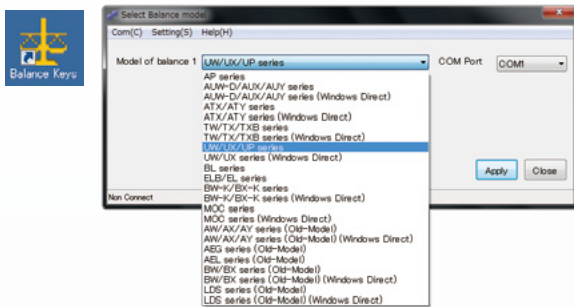

[Example of Worksheet for a Measurement Control Chart]

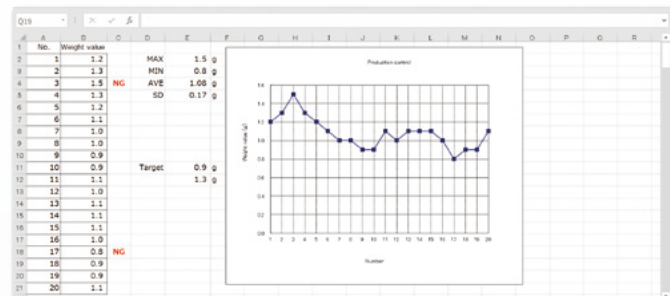

Using this software, users can load measurement data directly from the analytical balance into Excel® worksheets normally used by the customer.



balance keys

Search



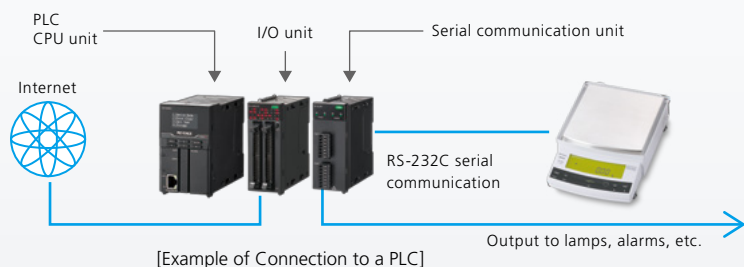

Proven Track Record of Compatibility with PLC

The UP series has a significant track record from being used in combination with various brands of PLC.

Consequently, it is perfect for automation or internet-of-things applications. It can also be used to configure very robust systems. Analytical balance connectivity has also been verified in partnership with the following PLC manufacturers.



[Example of Connection to a PLC]

Manufacturer	PLC Model	Communication Unit	Communication Method/Remarks	Appearance
Mitsubishi Electric Corporation	Q Series	QJ71C24-R2	Non-procedure method	
KEYENCE CORPORATION	KV-8000	KV-XL202	Protocol Studio Non-procedure method	
OMRON CORPORATION	CJ2 Series	CJ1W-SCU42	Protocol Macro Non-procedure method	
IDEC CORPORATION	FC6A Series	CPU internal or FC6A-PC1 communication cartridge	Non-procedure method Created using special tool	

LabSolutions Balance

Solution for Improving Productivity and Ensuring Data Reliability

Compliance with Electronic Records/Electronic Signature (ER/ES) Regulations and Measurement Data Management System

LabSolutions Balance (Optional)

Analytical balance data can be integrated into a LabSolutions analytical data management system compliant with electronic records/electronic signature (ER/ES) regulations. It also provides support for compliance with data integrity guidance.

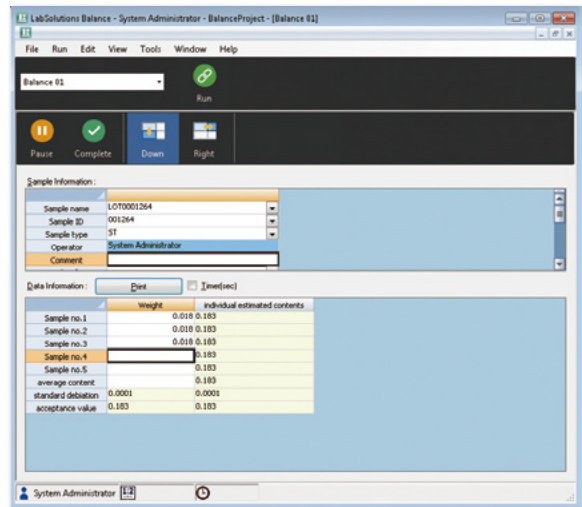

Solution for Improving Productivity and Ensuring Data Reliability

- Eliminates manual data entry and saves all measurement data in a safe database without any transcription errors.
- Reports can be created automatically after measurements, as appropriate for the given measurement method, such as for weight variation tests, loss-on-drying tests, or particle size tests.

Reports can also be created customized to customer requirements, such as for system suitability tests, content uniformity tests, or elution tests, based on HPLC or other analytical results.

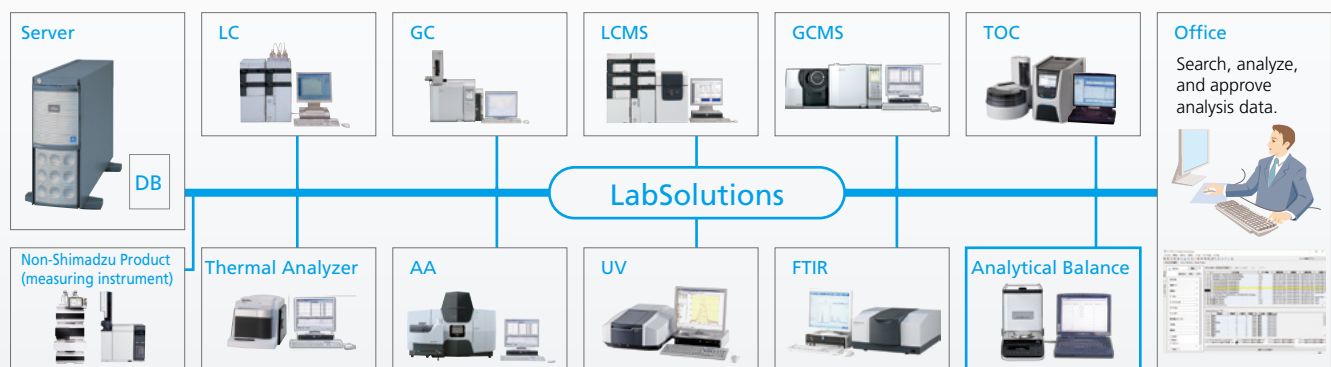

Integrated Management of Analytical Data via a Network System Using LabSolutions

Compliant with the Latest Data Integrity Guidance (including 21 CFR Part 11)

- Measurement results are saved in a database together with the sample ID, operator name, measurement date/time, serial number used, and other information, so that corresponding sample information can be quickly searched.
- User access settings can be specified so only specified users are able to create measurement templates, for example.
- Protects data from unauthorized modifications and unintended overwriting or deletion. Furthermore, analytical balance calibration results and all operation history events are saved together with corresponding reasons in the database as log events.

Specifications & Options

UP Series Specifications X Series with Internal Calibration Weights

Series	X Series (Small Pan Model with 0.001 g Minimum Display Value)				
	UP223X	UP423X	UP623X	UP823X	UP1023X
Model	UP223X	UP423X	UP623X	UP823X	UP1023X
Capacity	220g	420g	620g	820g	1020g
Minimum Display	0.001g				
External Calibration Weight Range for Span Calibration	100 to 220 g	100 to 420 g	100 to 620 g	400 to 820 g	500 to 1020 g
Repeatability (at Weighing Capacity)	≤0.001g				
Linearity	± 0.002g			± 0.003g	
Response Time (*1)	Approx. 1 sec.				
Sensitivity Stability Against Temperature Range	±3 ppm/°C (10 to 30 °C)				
Pan Size	Approx. 108 × 105 mm				
Weight	Approx. 3.4 kg				

Y Series without Internal Calibration Weights

Series	Y Series (Small Pan Model with 0.001 g Minimum Display Value)				
	UP223Y	UP423Y	UP623Y	UP823Y	UP1023Y
Model	UP223Y	UP423Y	UP623Y	UP823Y	UP1023Y
Capacity	220g	420g	620g	820g	1020g
Minimum Display	0.001g				
External Calibration Weight Range for Span Calibration	100 to 220g	100 to 420g	100 to 620g	400 to 820g	500 to 1020g
Repeatability (at Weighing Capacity)	≤0.001g				
Linearity	± 0.002g			± 0.003g	
Response Time (*1)	Approx. 1 sec.				
Sensitivity Stability Against Temperature Range	±3 ppm/°C (10 to 30 °C)				
Pan Size	Approx. 108 × 105 mm				
Weight	Approx. 2.7 kg				

*1 Indicated response time values are typical.



PSC (Perfect Self-Calibration) (UPX series only)

Automatically calibrates the balance if an ambient temperature change occurs that could affect sensitivity.



Use Click-CAL to automatically calibrate the balance at previously specified times (UPX series only).

This automatically calibrates the balance at pre-specified times (such as before starting work, during lunch, or after work hours).



One-Button Calibration (UPX series only)

Enables calibration by pressing a single key with one finger. That ensures calibration can be performed whenever needed.



Printout with Data and Time

If a printer (optional) is connected, then data can be marked with the date and time. Calibration results can also be marked with date and time, which is perfect for managing measurements or establishing traceability as required by GLP/GMP/ISO 9001 standards.



Leaves ISO-Compatible Calibration Record

Information identifying which balance was calibrated, when it was calibrated, and what the calibration result was can be automatically printed out by simply connecting a printer (optional). It requires absolutely no time-consuming setting process. Furthermore, the current date and time can be printed at any time during measurements.



LCD Screen with Backlight

This backlit LCD can be clearly read even in the darkest of environments.



Comparator Display

By specifying upper and lower limit values in advance, the comparator indicates whether the sample weight passes the criteria, is too heavy, or is too light.



Comparator Output

Acceptable, high, or low weight results or other pass/fail results can be indicated by an audible sound or output externally as a contact signal. (Optional comparator audible indicator or relay output interface required.)



Measuring Carats

The balance supports measurements in carats, momme, percent, and a variety of other measurement units. (The unit "momme" is only used for measuring pearls.)



Computer Connection Function

Systems can be connected to a computer via an RS-232C cable or using a USB-serial adapter kit. For more details, visit the Shimadzu website.



Piece Counting Function

A built-in piece counting function enables the balance to be used as a parts counter (counting balance).



Specific Gravity Measurement Function

The built-in specific gravity measurement function is based on the liquid immersion method. By installing the specific gravity measurement kit (optional), the balance can be used as a hydrometer.



X Series (Large Pan Model with 0.01 g Minimum Display Value)			X Series (Small Pan Model with 0.01 g Minimum Display Value)		X Series (Large Pan Model with 0.1 g Minimum Display Value)	
UP2202X	UP4202X	UP6202X	UP422X	UP822X	UP4201X	UP8201X
2200g	4200g	6200g	420g	820g	4200g	8200g
0.01g			0.01g		0.1g	
1000 to 2200 g	1000 to 4200 g	1000 to 6200 g	100 to 420 g	100 to 820 g	1000 to 4200 g	1000 to 8200 g
≤0.01g			≤0.008g		≤0.08g	
± 0.02g			± 0.01g		± 0.1g	
			Approx. 0.6 to 1.0 sec			
			±5 ppm/°C (10 to 30 °C)			
Approx. 170 × 180 mm			Approx. 108 × 105 mm		Approx. 170 × 180 mm	
Approx. 4.6 kg			Approx. 3.4 kg		Approx. 4.6 kg	

Y Series (Large Pan Model with 0.01 g Minimum Display Value)			Y Series (Small Pan Model with 0.01 g Minimum Display Value)		Y Series (Large Pan Model with 0.1 g Minimum Display Value)	
UP2202Y	UP4202Y	UP6202Y	UP422Y	UP822Y	UP4201Y	UP8201Y
2200g	4200g	6200g	420g	820g	4200g	8200g
0.01g			0.01g		0.1g	
1000 to 2200 g	1000 to 4200 g	1000 to 6200 g	100 to 420 g	100 to 820 g	1000 to 4200 g	1000 to 8200 g
≤0.01g			≤0.008g		≤0.08g	
± 0.02g			± 0.01g		± 0.1g	
			Approx. 0.6 to 1.0 sec			
			±5 ppm/°C (10 to 30 °C)			
Approx. 170 × 180 mm			Approx. 108 × 105 mm		Approx. 170 × 180 mm	
Approx. 2.9 kg			Approx. 2.7 kg		Approx. 2.9 kg	

Options and Peripheral Equipment

Description
Ionizer for Electronic Balance (Static Remover) STABLO-AP
Printer EP-100
Printer EP-110
RS-232C Cable 25P-9P (1.5 m)
USB-Serial Replacement Kit
Application Keyboard AKB-301
Windbreak Set (*1)
Windbreak Set (for large pan) (*2)
Glass Windbreak WBC-102
Large Size Windbreak WBC-502
In-Use Protective Cover (3 pcs) (For Large-Pan Models with 0.01 g Min. Display Value)
In-Use Protective Cover (5 pcs) (For Large-Pan Models with 0.1 g Min. Display Value)
In-Use Protective Cover (5 pcs) (For Small-Pan Model)
In-Use Protective Cover (5 pcs) (For Display and Key Part)
Animal Bucket Set (for Large Pan Models with 0.01 g Minimum Display Value)
Animal Bucket Set (for Large Pan Models with 0.1 g Minimum Display Value)
Specific Gravity Measurement Kit SMK-101A (For Large Pan Model) (Up to approximately 2kg for weighing capacity)
Specific Gravity Measurement Kit SMK-102 (For Small Pan Model)
Remote Display RDB-201
Remote Display RDB-202
Relay Output Interface IFB-RY1
RY1 Connection Cable
AC Adapter (*3)



Glass Windbreak WBC-102



Large Size Windbreak WBC-502



Animal Bucket Set



Printer EP-110

- *1: Included standard with small pan models with 0.001 g minimum display value.
- *2: Included standard with large pan models with 0.01 g minimum display value.
- *3: Included standard with main unit.

(Dimensional units: mm)

Small Pan Models with Weighing Capacity 1,020 g or less

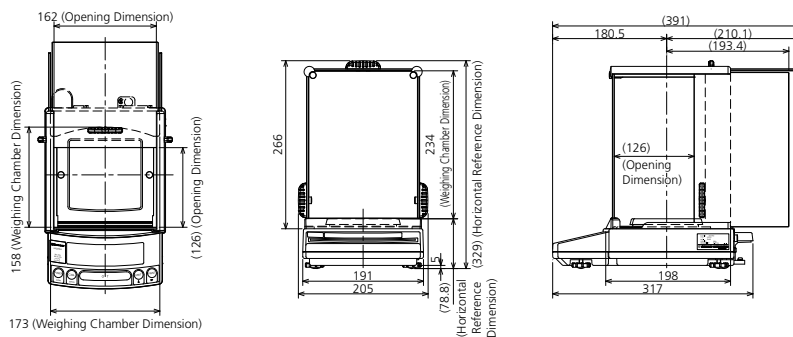

(shown with WBC-102 glass windbreak [sold separately] installed)

Large Pan Models with Weighing Capacity 2,200 g or more

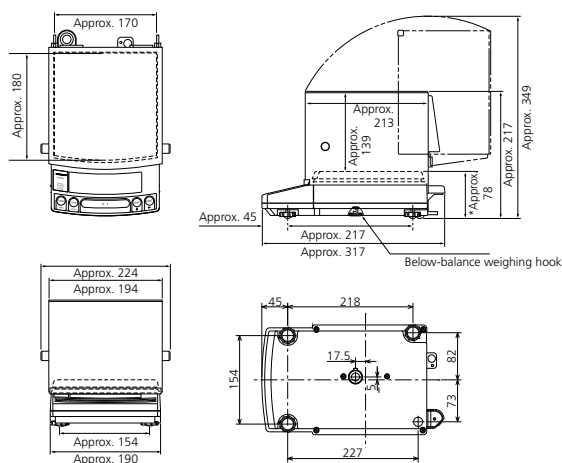

(shown with large windbreak [optional accessory, sold separately] installed)

Weight UP X series: Approx. 4.6 kg UP Y series: Approx. 2.9 kg

* Approx. 78 mm for models with 0.1 g minimum display value
Approx. 81 mm for models with 0.01 g minimum display value

Small Pan Models with Weighing Capacity 1,020 g or less

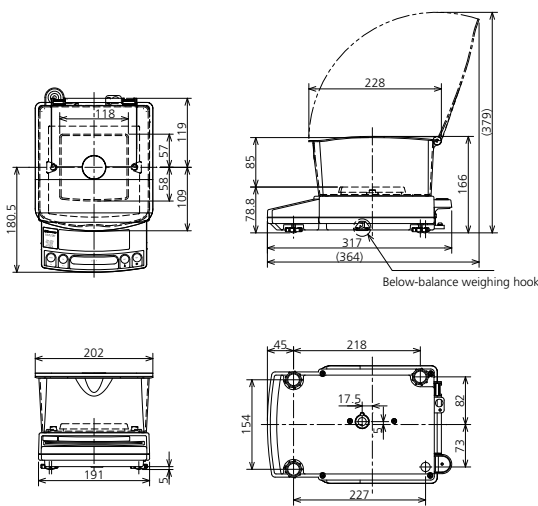

(shown with the standard windbreak set installed on a model with 0.001 g minimum display value)

Weight UP X series: Approx. 3.4 kg UP Y series: Approx. 2.7 kg

UniBloc, STABLO, LabSolutions, LCMS, and GCMS are trademarks of Shimadzu Corporation.
Windows and Excel are trademarks or registered trademarks of Microsoft Corporation in the USA and other countries.



For Research Use Only. Not for use in diagnostic procedures.

This publication may contain references to products that are not available in your country. Please contact us to check the availability of these products in your country.

Company names, products/service names and logos used in this publication are trademarks and trade names of Shimadzu Corporation, its subsidiaries or its affiliates, whether or not they are used with trademark symbol "TM" or "®".

Third-party trademarks and trade names may be used in this publication to refer to either the entities or their products/services, whether or not they are used with trademark symbol "TM" or "®".

Shimadzu disclaims any proprietary interest in trademarks and trade names other than its own.

The contents of this publication are provided to you "as is" without warranty of any kind, and are subject to change without notice. Shimadzu does not assume any responsibility or liability for any damage, whether direct or indirect, relating to the use of this publication.

Shimadzu Corporation

www.shimadzu.com/an/